



INSTALLATION INSTRUCTIONS

Accessory
INTERIOR PANEL SET
P/N 08Z03-SWA-100A

Application
2008 CR-V
(EX-L, EX-L NAVI)

Publications No.
All 37510

Issue Date
AUG 2007

Interior Panel Kit B

Shifter panel

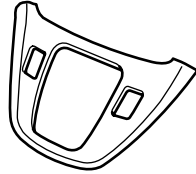

Left center panel

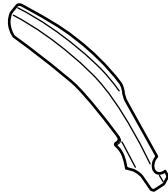

Right center panel

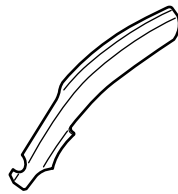

Left outlet panel

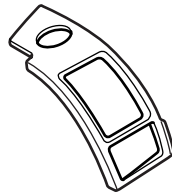

Right outlet panel

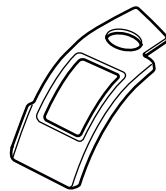

Left front door panel trim

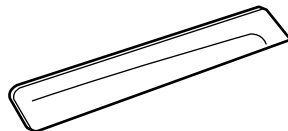

Right front door panel trim

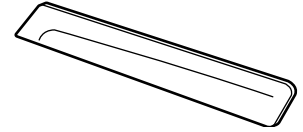

Left rear door panel trim



Right rear door panel trim

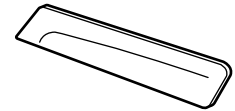

TOOLS AND SUPPLIES REQUIRED

- Masking tape
- Shop towel
- Isopropyl alcohol

INSTALLATION

NOTE

- Be careful not to damage the body paint finish.
 - This interior trim kit should be installed only if the ambient air temperature is 60°F (15°C) or above.
1. Using isopropyl alcohol on a shop towel, clean the area where the right outlet trim will attach.

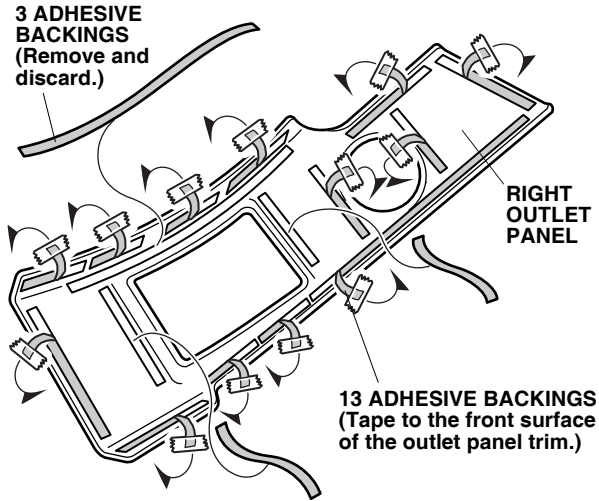

2. Peel back one inch from the end of the 13 adhesive backings shown, and attach them to the front of the right outlet panel with masking tape. Remove and discard the three remaining adhesive backings from the trim.
3. Position the right outlet panel trim on the existing outlet panel, and make sure the lower edges align properly. While applying light pressure, carefully remove the adhesive backings. Remove the upper adhesive backings first, then the lower ones. Press and hold the right outlet panel firmly with the palm of your hand, particularly at the edges, for 30 seconds.

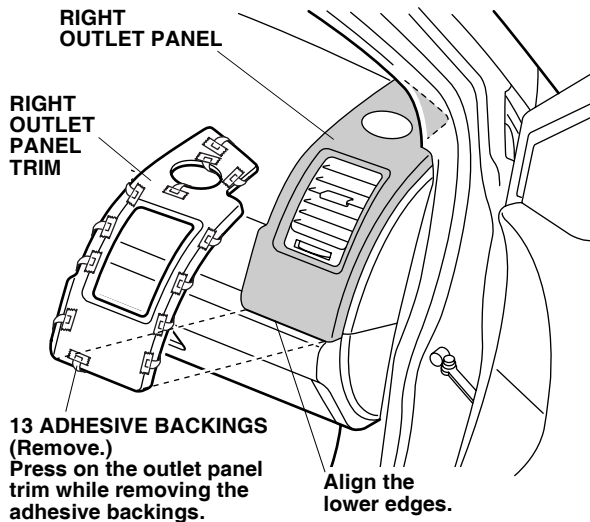

4. Repeat steps 1 thru 3 to install the left outlet panel trim.
5. Using isopropyl alcohol on a shop towel, clean the area where the shifter panel trim will attach.

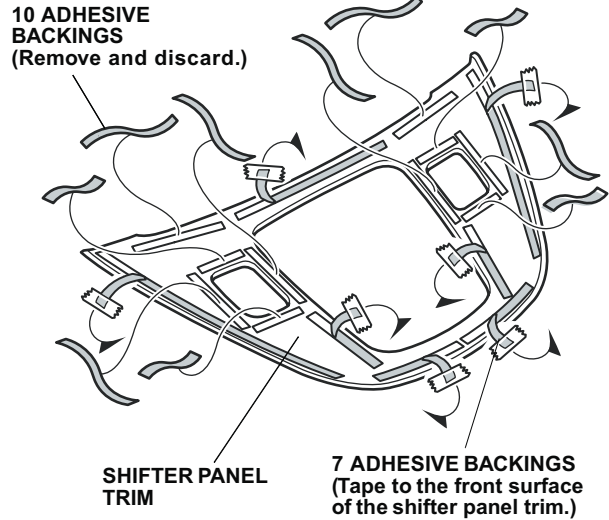

6. Peel back one inch from the end of the seven adhesive backings shown, and attach them to the front of the shifter panel trim with masking tape. Remove and discard the remaining 10 adhesive backings from the trim.
7. Position the shifter panel on the existing shifter panel, and make sure the cutout aligns properly. While applying light pressure, carefully remove the adhesive backings. Remove the upper adhesive backings first, then the lower ones. Press and hold the shifter panel trim firmly with the palm of your hand, particularly at the edges, for 30 seconds.

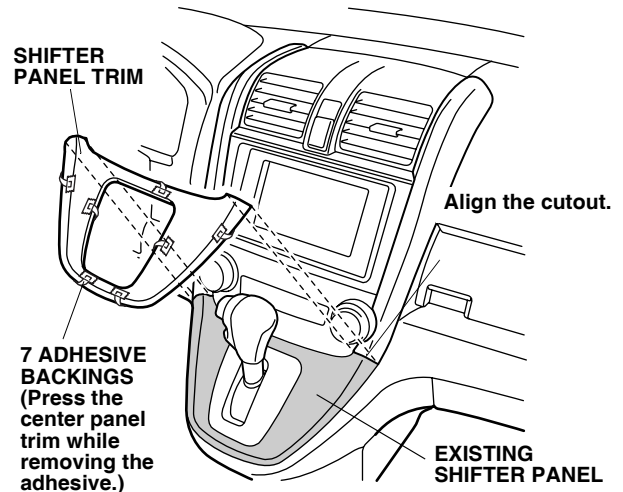

- Using isopropyl alcohol on a shop towel, clean the area where the right center panel trim will attach.

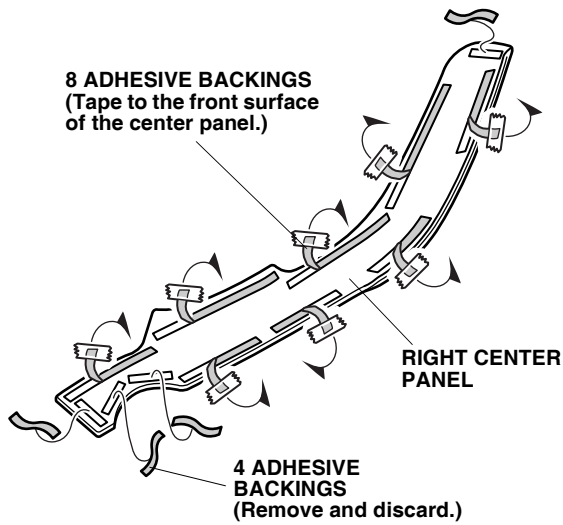

- Peel back one inch from the end of the eight adhesive backings shown, and attach them to the front of the right center panel trim with masking tape. Remove and discard the remaining four adhesive backings from the trim.
- Position the right center panel trim on the existing center panel, and make sure the cutout aligns properly. While applying light pressure, carefully remove the adhesive backings. Press and hold the right center panel trim firmly with the palm of your hand, particularly at the edges, for 30 seconds.

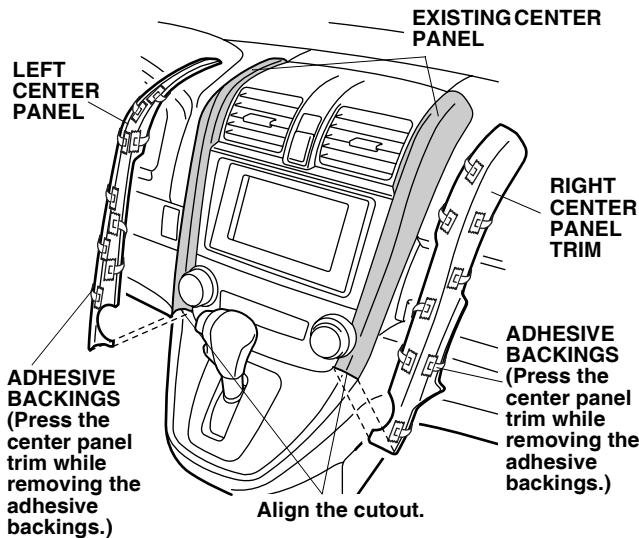

- Repeat steps 8 thru 10 to install the left center panel trim.

- Using isopropyl alcohol on a shop towel, clean the area where the left front door panel trim will attach.

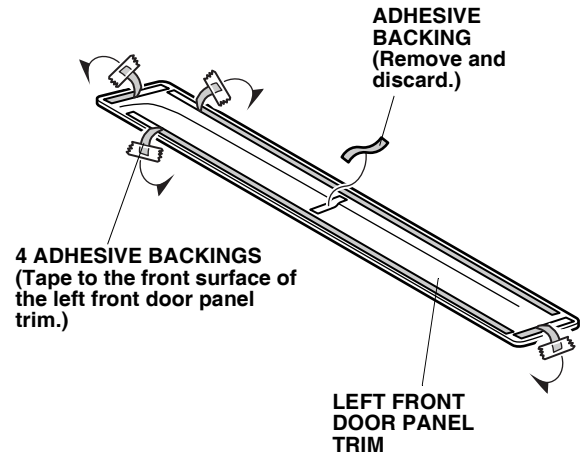

- Peel back one inch from the end of the four adhesive backings shown, and attach them to the front of the left front door panel trim with masking tape. Remove and discard the remaining adhesive backing from the trim.
- Position the left front door panel trim on the existing door panel. While applying light pressure, carefully remove the adhesive backings. Press and hold the left front door panel trim firmly with the palm of your hand, particularly at the edges, for 30 seconds.

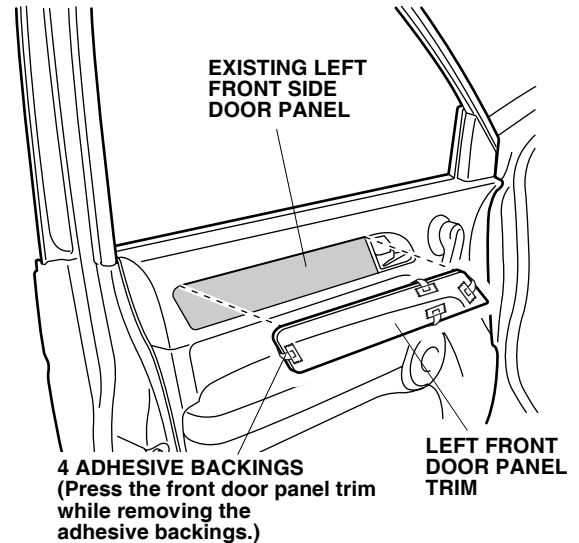

- Repeat steps 12 thru 14 to install the door panel trims for the remaining three doors.